



Series

31

310

311

GENERAL SPECIFICATIONS

Series 31 Sea Level Rated

These reliable coaxial connectors have been in production since 1950. Available as plug connectors, kits and cable assemblies, they mate all series 311 Cond. 1 connectors and adaptors. Rated at 6.5 KVDC for sea level use only. The operating temperature range is -40°C to +85°C.

Series 310 For Operation at Reduced Pressure

A sealed version of the series 31 that mates all series 311 Cond. 1 receptacles and adaptors. Rated at 15 KVDC. The operating temperature range is -40°C to +85°C.

Series 311 For Operation at Reduced Pressure

This series features seals for reduced pressure operation, a shell to shell grounding spring finger shield, a hooded female socket and three polarizing conditions. The bayonet coupling has machined rings to designate polarization by either sight or feel. Rated at 15 KVDC. The operating temperature range is -40°C to +85°C.

Applications

These connectors are widely used in laboratory experiments and field testing of ordnance products.

Interface cleaning

High voltage connectors must always be cleaned prior to mating. The proper cleaning method is to wipe or spray the interface area with isopropyl alcohol and immediately blow an inert gas such as dry nitrogen over the interface area until dry. No other cleaning method should be attempted.

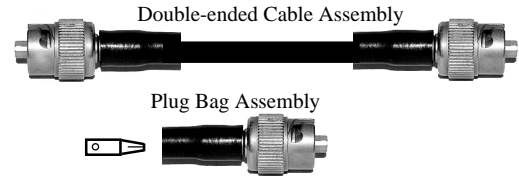

Series 311

Polarization
Series 311 connectors feature interface polarization which allows the system design engineer to use the same basic connector in three different circuits without concern of mismatching the circuits.
Polarization is controlled by the numbers and/or dissimilar spacing of the bayonet lugs on the receptacle. There are three conditions of polarization available.

Cond. 1

Cond. 2

Cond. 3

Identification
Grooves have been machined on the knurled coupling rings to provide both visual and touch identification for the three conditions of polarization.

GENERAL SPECIFICATIONS

	Series 31	310	311
Sea level voltage rating (mated)	6.5 KVDC	15 KVDC	15 KVDC
Reduced pressure rating (mated)	NA	15 KVDC	15 KVDC
Operating temperature	-40°C to +85°C	-40°C to +85°C	-40°C to +85°C
Bayonet coupling	Yes	Yes	Yes
Mating polarization	No	No	Yes
Altitude & moisture seals	No	Yes	Yes
Body material/finish	Brass/gold	Brass/gold	Brass/gold
Bayonet coupling material/finish	Brass/nickel	Brass/nickel	Brass/nickel
Male contact diameter (inches/mm)	0.052/1.3	0.052/1.3	0.052/1.3
Male contact material/finish	Brass/gold	Brass/gold	Brass/gold
Female contact material/finish	Be Cu/gold	Be Cu/gold	Be Cu/gold
Spring finger grounding	No	No	Yes
Hooded female contact	No	No	Yes

Cable Assembly
Length vs Manufacturing
Tolerance Chart

Length: feet/M	Tolerance: inches/mm
7.5/2.2 or less	0.25/6.3
7.5/2.2 to 12.5/3.8	1.0/25.4
12.5/3.8 to 22.5/6.8	1.50/38.1
22.5/6.8 to 35/10.6	2.0/50.8
35/10.6 to 50/15.2	3.0/76.2
50/15.2 to 70/21.3	4.0/101.6
70/21.3 to 100/30.4	5.0/127



Series

31

6.5 KVDC

Sea Level Rating
Operating Temperature:
-40°C to +85°C

Plugs

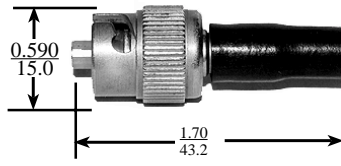

P/N 167-0669

Cable connector (female contact)
6.5 KVDC rated
Uses type "C" coaxial cable, P/N 167-2669
Solder braid termination
Mating connectors: Mates series 311 Cond. 1 receptacles and adaptors shown on pp. 6 and 7 of this catalog
Ordering: Specify part number
For general specifications, see p. 2
For cable preparation and assembly instructions, see p. 43
Bulk cable: See p. 40 for ordering and specifications

Receptacles (Male)

Series 31 plugs and cable assemblies mate series 311 Cond. 1 receptacles
Series 311 Cond. 1 receptacles are designated as standard items and are shown on p. 5 of this catalog

Adaptors

A selection of series 311 Cond. 1 adaptors are available on special order for use with series 31 connectors and cable assemblies. Series 311 Cond. 1 adaptors are shown on pp. 6 and 7 of this catalog

Cable Assembly Ordering Information

Order by P/N. Use "N" for inches, "F" for feet
Example: Cable Assembly 178-7034 10 feet 8 inches in length is ordered as P/N 178-7034-10F-8N

Cable Assemblies

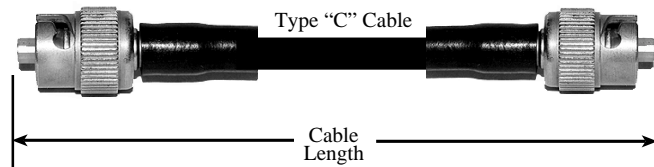

P/N 167-1615

Double-Ended Cable Assembly
6.5 KVDC rated
Sea level operation
Uses type "C" cable P/N 167-2669
Solder braid termination
Mating connectors: Mates all series 311 Cond. 1 receptacles and adaptors. See pp. 6 and 7
100% voltage test: 7.5 KVDC @ sea level
Ordering: See cable assembly ordering information below
Bulk cable: See p. 40 for ordering and specifications

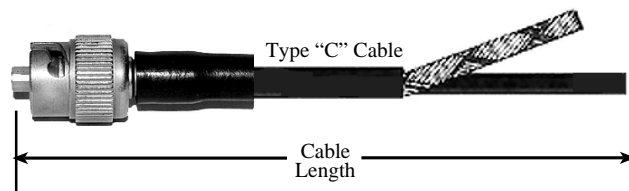

P/N 167-1617

Single-Ended Pigtail Cable Assembly
6.5 KVDC rated
Sea level operation
Uses type "C" cable P/N 167-2669
Solder braid termination
Mating Connectors: Mates all series 311 Cond. 1 receptacles and adaptors. See pp. 6 and 7
100% voltage test: 7.5 KVDC @ sea level
Ordering: See cable assembly ordering information
Bulk cable: See p. 40 for ordering and specifications



Series

310

15 KVDC

Reduced Atmospheric Pressure

Operating Temperature:

-40°C to +85°C

Plugs

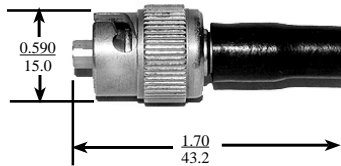

P/N 167-4356

Cable connector (female contact)

15 KVDC rated

Uses type "C" cable P/N 167-2669

Crimp braid termination

Mating connectors: Mates series 311

Cond. 1 receptacles and adaptors

For general specifications, see p. 2

For cable preparation and assembly instructions, see p. 43

Bulk cable: See p. 40 for ordering and specification

Receptacles (Male)

Series 310 plugs and cable assemblies

mate all series 311 Cond.1 receptacles

Series 311 Cond. 1 receptacles are designated as standard items and are shown on p. 5 of this catalog

Adaptors

A selection of series 311 Cond. 1 adaptors are available on special order for use with series 310 connectors and cable assemblies. Series 311 Cond. 1 adaptors are shown on pp. 6 and 7 of this catalog

Cable Assembly Ordering Information

Order by P/N. Use "N" for inches, "F" for feet
Example: Cable Assembly
178-7034 10 feet 8 inches
in length is ordered as
P/N 178-7034-10F-8N

Cable Assemblies

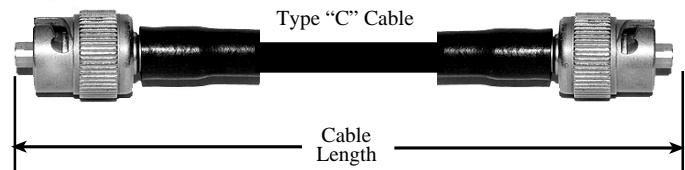

P/N 167-4358

Double-Ended Cable Assembly

15 KVDC rated

Uses type "C" cable P/N 167-2669

Crimp braid termination

Mating connectors: Mates series 311 Cond. 1 receptacles and adaptors. See pp. 6 and 7

100% voltage test: 21 KVDC @ 70,000 ft. simulated altitude and ambient temperature

Ordering: See cable assembly ordering information below

Bulk cable: See p. 40 for ordering and specification

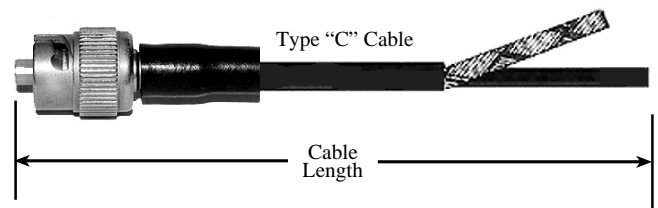

P/N 167-4360

Single-Ended, Pigtail Cable Assembly

15 KVDC rated

Uses type "C" cable P/N 167-2669

Crimp braid termination

Mating connectors: Mates series 311 Cond. 1 receptacles and adaptors. See pp. 6 and 7

100% voltage test: 21 KVDC @ 70,000 ft. simulated altitude and ambient temperature

Ordering: See cable assembly ordering information

Bulk Cable: See p. 40 for ordering and specification



Series

311

15 KVDC

Reduced

Atmospheric Pressure

Operating Temperature:

-40°C to +85°C

Polarized

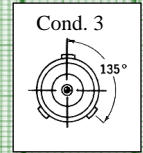
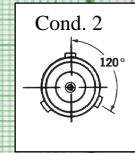
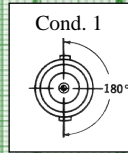

Plugs



Cond. 1 (shown)
P/N167-7624-1**



Cond. 2
P/N 167-7624-2**



Cond. 3
P/N 167-7624-3**

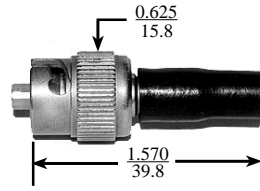

Polarized

Plug (female)

Hooded socket contact

Grounding spring finger sleeve

Uses type "C" cable **P/N 167-2669**

Crimp braid termination

*Standard item

** Special order item

For general specifications, see p. 2

For cable preparation and assembly instructions, see

p. 43

Bulk cable: See p. 40 for ordering & specifications

Receptacles (Male)



Cond. 1 (shown)
P/N167-7792*



Cond. 2
P/N 167-7793**



Cond. 3
P/N 167-7794**

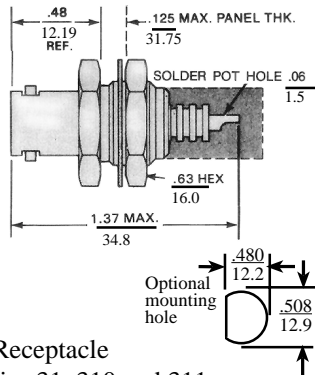

Polarized

Non-sealed Front Mount Receptacle

*Standard item. Mates series 31, 310 and 311

series plugs and cable assemblies

100% voltage test: 21 KVDC. Sea level

** Special order item

Cable Assembly

Ordering Information

Order by P/N. Use "N" for inches, "F" for feet
Example: Cable Assembly 178-7034 10 feet 8 inches in length is ordered as **P/N 178-7034-10F-8N**

Cable Assemblies

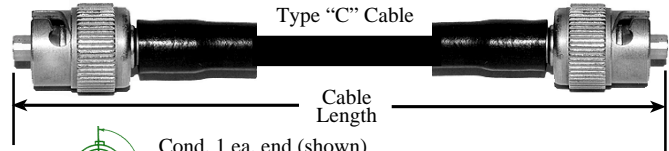

Cond. 1 ea. end (shown)
P/N 178-7026 Standard cable assembly



Cond. 2 ea. end
P/N 178-7027 Non-standard cable assembly. Available on special order only



Cond. 3 ea. end
P/N 178-7028 Non-standard cable assembly. Available on special order only

Polarized

Double-Ended Cable Assembly

15 KVDC rated

Uses type "C" cable **P/N 167-2669**

Crimp braid termination

Mating connectors: Mates all series 311 receptacles with corresponding Polarization Condition.

100% voltage test: 21 KVDC @ 70,000 ft. (simulated) and ambient temperature

Ordering: See cable assembly ordering information, below

Bulk cable: See p. 40 for ordering and specification

For general specifications, see p. 2

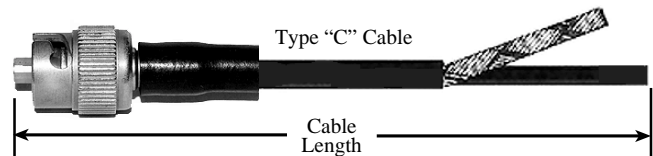

Cond. 1 ea. end (shown)
P/N 178-7032 Standard cable assembly



Cond. 2 ea. end
P/N 178-7033 Non-standard cable assembly. Available on special order only



Cond. 3 ea. end
P/N 178-7034 Non-standard cable assembly. Available on special order only

Polarized

Single-Ended, Pigtail Cable Assembly

15 KVDC rated

Uses type "C" cable **P/N 167-2669**

Crimp braid termination

Mating connectors: Mates all series 311 receptacles with corresponding Polarization Condition

100% voltage test: 21 KVDC @ 70,000 ft. (simulated) and ambient temperature

Ordering: See cable assembly ordering information, left